

---

Digital Temperature Controller  
Model: FE400

---

**Operation Manual** Ver 2.5

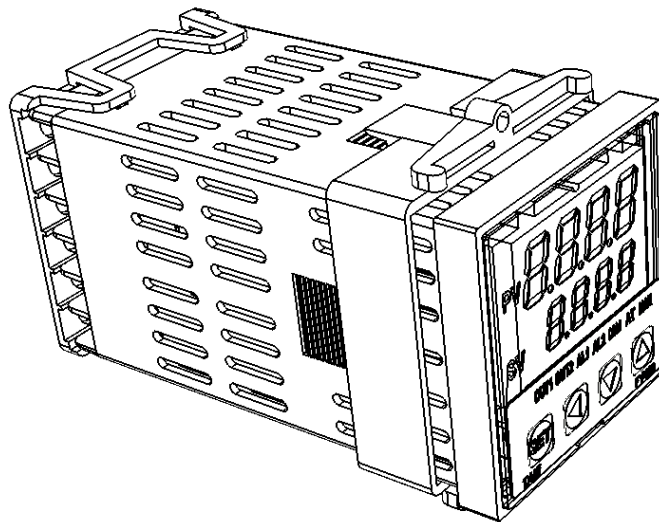

台灣儀控股份有限公司  
TAIWAN INSTRUMENT & CONTROL CO., LTD

# Contents

1. Notice.....	1
2. Order & Label information.....	1
2.1 Order information .....	1
2.2 Label Explanation.....	2
3. Specifications .....	2
4. Input range table .....	3
5. Packing list.....	3
6. Parts description .....	4
7. Installation.....	4
7.1 Dimensions.....	4
7.2 Panel cutout .....	4
8. Terminal arrangement.....	5
9. Mounting procedures .....	6
9.1 Before wiring .....	6
9.2 After wiring .....	6
10. Basic function setting.....	7
10.1 Input type setting.....	7
10.2 SV value setting .....	7
10.3 RUN/STOP mode selection .....	7
10.4 Auto tuning execution.....	7
10.5 PID value setting .....	8
10.6 ON/OFF control setting .....	8
10.7 Alarm mode setting .....	8
10.8 Alarm value setting.....	9
10.9 Manual mode selection .....	9
11. Flow chart of parameters setting.....	10
11.1 Levels operation mode .....	10
11.2 Levels operation diagram .....	10
11.3 Data lock (LCK) function.....	10
11.4 Level 1 (User Level) all parameters display .....	11
11.5 Level 2 (PID Level) all parameters display .....	11
11.6 Level 3 (Input Level) all parameters display .....	12
11.7 Level 4 (Setting Level) all parameters display .....	13
12. Troubleshooting .....	13
13. Parameters hide / display table on Level 4.....	14
14. List of parameters .....	16
14.1 COMM GROUP.....	16
14.2 DI GROUP.....	16

---

14.3	ALARM GROUP .....	16
14.4	PID GROUP .....	17
14.5	SV GROUP .....	17
14.6	AT GROUP .....	18
14.7	SYSTEM GROUP .....	18
14.8	CONTROL GROUP.....	19
14.9	INPUT GROUP .....	20
14.10	TRANSMISSION GROUP.....	21
14.11	HBA GROUP .....	21
15.	Digital input function.....	22
15.1	DIS mode table.....	22
15.2	DI for 3SV .....	23
16.	Alarm action explanation .....	24
16.1	Alarm mode .....	24
16.2	Alarm special function .....	25
17.	Control module modification .....	26
17.1	RELAY Control .....	26
17.2	SSR Control .....	26
17.3	Linear Control.....	26
17.4	Output calibration flowchart.....	27
17.5	Output calibration steps .....	28
18.	Input type modification .....	29
18.1	Modify to Thermocouple.....	29
18.2	Modify to RTD .....	29
18.3	Modify to Linear (4~20mA).....	29
18.4	Input calibration flowchart .....	30
18.5	Input calibration steps .....	31
19.	Communication register address table .....	32

---



Thanks for purchase FE series Digital Temperature Controller.  
 Before using controller, please make sure the spec and type is correspond your demand.  
 Please check the Voltage` Frequency and input/output range.  
 Please follow the operation manual and pass the user to keep it.  
 FE series controller is the newest generation using the latest technology and SMT equipment plus our  
 plentiful exploitation experience to publish it.

## 1. Notice



### Warning

1. Danger! Electric Shock!
2. DON'T touch AC power wiring terminals when controller has been activated!
3. Make sure the power off until all of the wirings are completed!



### Warning

1. Please confirm the AC power wiring to controller is correct, otherwise it will be caused an aggravated damage on controller.
2. Make sure to use the rated power supply (AC85~265V or DC24V), otherwise it will be caused severely damage on controller.
3. Please confirm wirings are connected with correct terminals (Input, Output, Alarm).
4. Use M3 screw-compatible crimp-on terminals with an insulation sleeve, as shown below

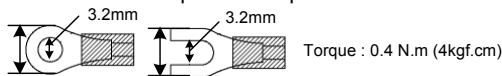

5. Avoid installing controller in following spaces:
  - I. A place where the ambient temperature may reach beyond the range from -10 to 50°C
  - II. A place where the ambient humidity may reach beyond the range from 20 to 90% RH.
  - III. A place where the controller likely to come into contact with water, oil, chemicals, steam and vapor.
  - IV. A place where the controller is subject to interface with static electricity, magnetism and noise.
6. For thermocouple (TC) input, use shield compensating lead wire.
7. For RTD input, use shield wires which have low resistance and no resistance difference between 3 wires.

## 2. Order & Label information

### 2.1 Order information

FE400	Output 1	Output 2	Alarm	TRS	DI	COMM	Input type	Power
	1	0	1	0	0	0	0 1	A
	0 None	0 None	0 None	0 None	0 None	0 None	See input Range type code	A AC 85~265V
	1 Relay	1 Relay	1 1 Set	1 4~20mA	E 2 Points	B RS-485		D DC 24V
	2 Voltage Pulse (SSR Drive)	2 Voltage Pulse (SSR Drive)	2 2 Sets	2 0~20mA				
	3 4~20mA	3 4~20mA		A 0~5V				
	4 0~20mA	4 0~20mA		B 0~10V				
	A 0~5V	A 0~5V		C 1~5V				
	B 0~10V	B 0~10V		D 2~10V				
	C 1~5V	C 1~5V						
	D 2~10V	D 2~10V						

※ : ■ Block means optional functions with additional charge.

## 2.2 Label Explanation

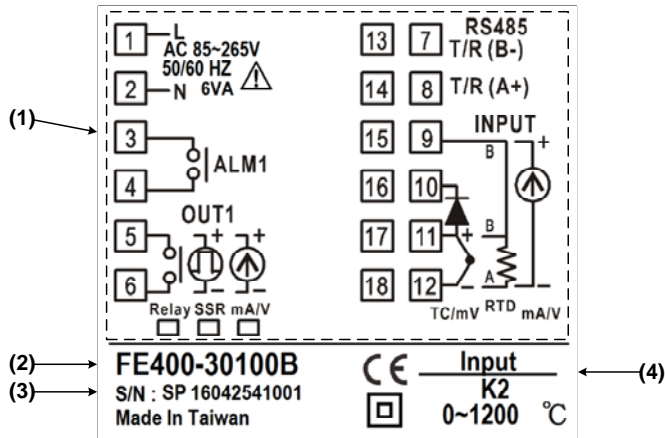

NO.	Explanation	Indication Example
(1)	Terminal arrangement	Terminal arrangement for the FE400
(2)	Model Number	FE400-30100B
(3)	Series Number	16042541001
(4)	Input type	Multi-range (Multi-range input)

## 3. Specifications

Power supply voltage		85 ~ 265 VAC,DC 24V (Optional)
Frequency		50/60 Hz
Power consumption		Approx 6VA
Memory		Non-volatile memory EEPROM
Sensor input ※ Please refer to input range table		Accuracy : 0.2% FS
		Sample time 50ms
		TC : K \ J \ R \ S \ B \ E \ N \ T \ W \ PL II \ L
		RTD : PT100
Linear :		0~20mA \ 4~20mA 0~1V \ 0~5V \ 0~10V \ 0~2V \ 1~5V \ 2~10V 0~25mV \ 0~50mV \ 10~50mV \ 0~70mV
Control output	Relay	SPST-NO, 250 VAC, 8A (resistive load), electrical life: 100,000 operations
	SSR driver	ON: 24 V OFF: 0V max. load current: 20 mA, with short-circuit protection circuit
	Linear	4~20mA,0~20mA, 0~5V,0~10V, 1~5V,2~10V
Control method		ON-OFF or P,PI,PID control
Alarm output		SPST-NO, 250VAC, 5A (resistive load), electrical life: 100,000 operations
Transmission		PV1,SV1,PV2,OP1
Digit input		2 points
Communi- -ication	Interface	RS-485 Maximum unit : 32 pcs Maximum distance : 1200m
	Protocol	Modbus RTU , TAIE
	Parity	None , odd , even
	Data bit	8bit
	Stop bit	1 or 2 bit
	Baud rate	2400,4800,9600,19200,38400,57600,115200 bps
	Delay time	0~250 ms
Special features		3 SV choose(SV1,SV2,SV3), Power-on soft start, Timer function (1 minute to 99 hours,59 minutes)
Operating temperature humidity		-10 ~ 50°C (with no icing or condensation) 20% ~ 90% RH
Storage temperature		-25 ~ 65°C (with no icing or condensation)
Dimension		W 26 x H 75 x D 90 mm
Weight (approx)		Approx 120g

#### 4. Input range table

Model	Input type		Code	Range	
				°C	°F
TC	K	K1	01	-50.0~400.0	-50.0~750.0
		K2	02	0~1200	0~2190
	J	J1	03	-50.0~400.0	-50.0~750.0
		J2	04	0~1200	0~2190
	R	R	05	0~1760	0~3200
	S	S	06	0~1760	0~3200
	B	B	07	0~1820	0~3300
	E	E	08	0~900	0~1650
	N	N	09	0~1300	0~2370
	T	T1	10	-199.9~400.0	-199.9~750.0
		T2	11	-199~400	-199~750
	W	W	12	0~2320	0~4200
	PL II	PL II	13	0~1200	0~2190
	L	L	14	0~800	0~1470
RTD	PT100	DP1	15	-199.9~600.0	-199.9~999.9
		DP2	16	-199~600	-199~1110
		DP3	17	0~600	0~1110
Linear	AN1	0~25mV	18	-1.999~9.999 -19.99~99.99 -199.9~999.9 -1999~9999	
	AN2	0~50mV	19		
		0~20mA	20		
		4~20mA	21		
		0~1V	22		
		0~5V	23		
		0~10V	24		
		0~2V	25		
		1~5V	26		
		2~10V	27		
		other	28		
	AN3	0~70mV	29		

#### 5. Packing list

- |    |                              |      |
|----|------------------------------|------|
| 1. | Temperature Controller ..... | 1pcs |
| 2. | Fix bracket.....             | 1pcs |
| 3. | Terminal protect cover.....  | 1pcs |
| 4. | Manual.....                  | 1pcs |

## 6. Parts description

	1	PV	Indicates PV (measured value) and character information such as parameter codes and error codes (Red)		
	2	SV	Indicates SV (target set value) and parameter values (Green)		
	3	LED	OUT1	Lamp lit when OUT1 is activated (Orange)	
			OUT2	Lamp lit when OUT2 is activated (Orange)	
			AL1	Lamp lit when Alarm 1 is activated (Red)	
			AL2	Lamp lit when Alarm 2 is activated (Red)	
			COM	Lamp lit when controller response data (Orange)	
			AT	Lamp lit when Auto tuning is activated (Orange)	
			MAN	Lamp lit when controller in manual mode or get error condition (Orange)	
	4	Keypad	SET	SET	Used for parameter calling up and set value registration
			←	SHIFT	Shift digits when settings are changed
			▽	DOWN	Decrease numerals
			△	UP	Increase numerals

## 7. Installation

### 7.1 Dimensions

(Unit : mm)

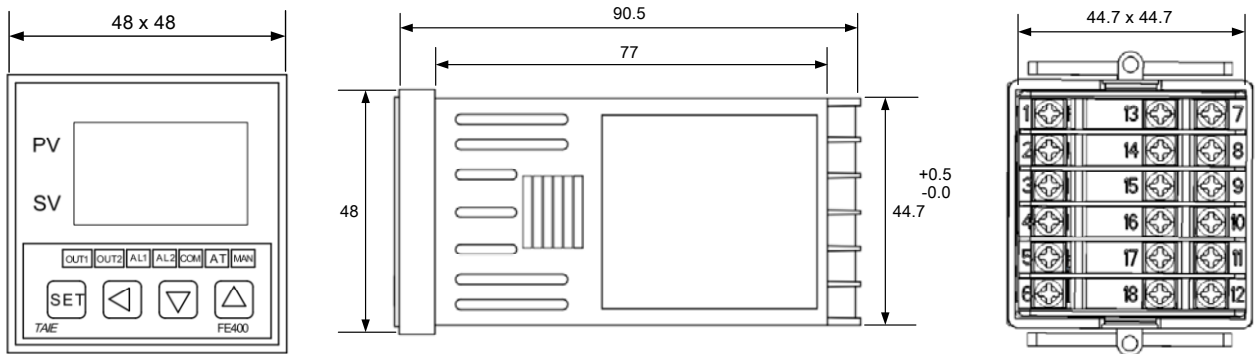

### 7.2 Panel cutout

(Unit : mm)

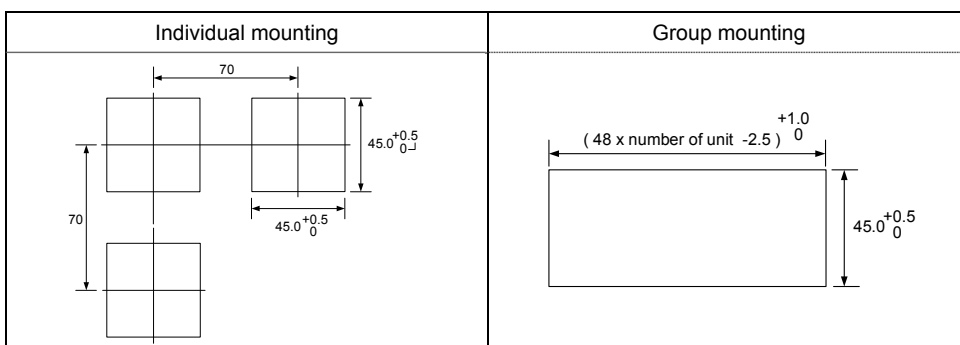



## 8. Terminal arrangement

### Notice

Make sure the power off until all of the wirings are completed!  
 Turn the power supply to the instrument off before wiring or checking.  
 Working on or touching the terminal with the power switched on may result in severe injury or death due to electric shock.

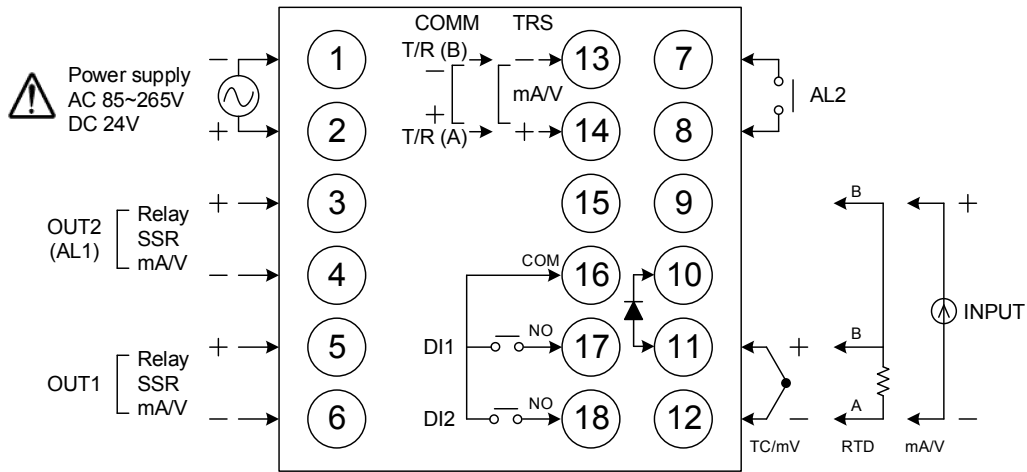

Power	
Output-1	
Output-2	
Alarm-1 Alarm-2	
Communication	
Transmission	
Digit Input	
Input	

## 9. Mounting procedures

### 9.1 Before wiring

1. Turn controller to upside down, control panel forward face the label side, will see the little point in the square hole.
2. Use "-" type screwdriver (head width <math>< 4\text{mm}</math>) and vertically insert the square hole into the top of the shell about 1 mm gap.
3. Please be noted: take the screwdriver into the slit (do not withstand and pressed down the plastic Exposed hook, it will cause the plastic exposed hook broken)
4. Push forward the screwdriver with leverage theory to extrusion the controller from the opposition direction.
5. After pulling out the body, you can exchange output module or add the additional option or repairing.

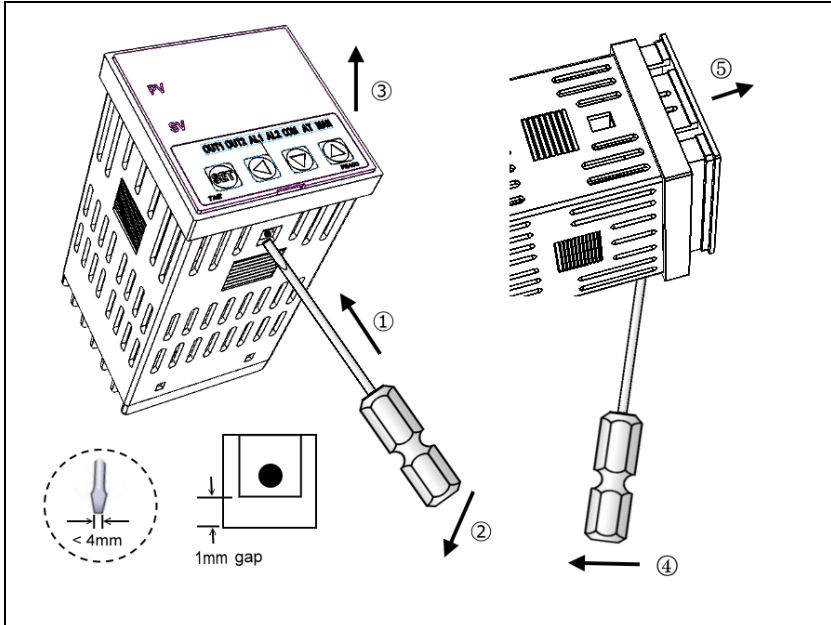





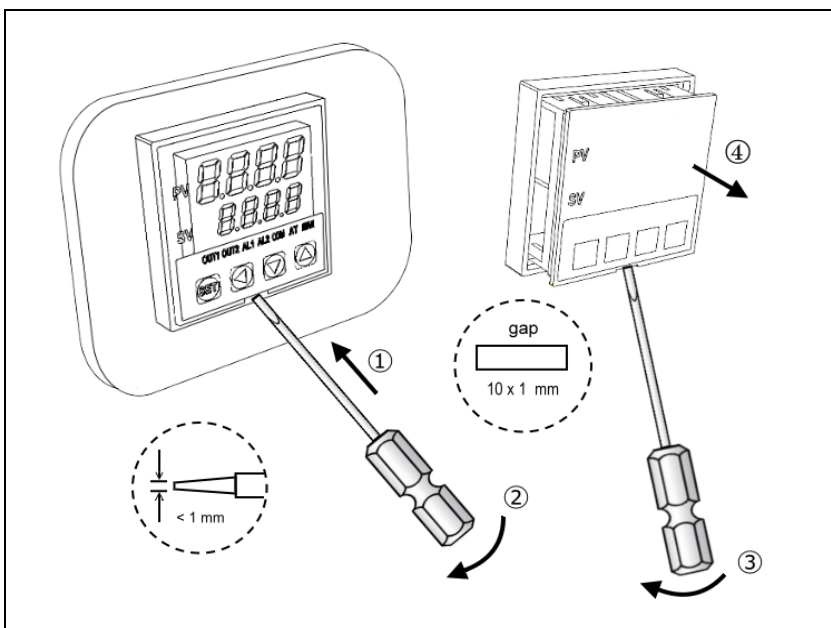











### 9.2 After wiring

1. It can only be pulled out from the front direction main body if the controller is already installed on the machine.
2. Use a small - type screwdriver (front thickness <math>< 1\text{mm}</math>) and let screwdriver front to insert the controller panel below the small rectangular hole about 1 mm gap.
3. Use the screwdriver head to insert 2 ~ 3mm and withstand the controller to go to the opposite direction to squeeze and pick up the controller body.
4. If the body is exposed little it cannot be a complete extrusion. Take the screwdriver to insert the front two square holes of the exposed transparent cover of the body.
5. Use a small "-" type screwdriver to insert the square hole and then forward and pick the hole and pull out the controller body via the opposite direction of extrusion.
6. After pulling out the body, you can exchange output module or add the additional option, or repairing.















## 10. Basic function setting

### 10.1 Input type setting















1.	PV  SV 	Operation panel display.	2.	PV  SV 	Hold  key +  key 3 seconds, then the controller will enter LEVEL_3 upper display show "INP1" lower display show current input type.
3.	PV  SV 	When  key is pressed, the lower display flashes.	4.	PV  SV 	Press  key and  key to set the desire input type.
5.	PV  SV 	Press  key to store new value of INP1.	Modify input type needs to interchange of jumper location, and it needs to recalibration for linear input type change. Please refer to ch18 Input type modification.		

※ : INP1 setting value refer the "Input range table"















### 10.2 SV value setting

1.	PV  SV 	Operation panel display.	2.	PV  SV 	When  key is pressed, the lower display flashes.
3.	PV  SV 	Press  key to choose digit and pressing  key and  key to set the desire value.	4.	PV  SV 	Press  key to store new value of SV.





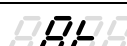





### 10.3 RUN/STOP mode selection

1.	PV  SV 	Operation panel display.	2.	PV  SV 	Press  key to get parameter setup display, "r-s" shown on the upper display.
3.	PV  SV 	When  key is pressed, the lower display flashes.	4.	PV  SV 	Press  key or  key to select run/stop mode.
5.	PV  SV 	Press  key to store new value of R-S.	When controller selection STOP mode, close all OUTPUT and ALARM function.		

### 10.4 Auto tuning execution



















1.	PV  SV 	Operation panel display.	2.	PV  SV 	Press  key to get parameter setup display, "AT" shown on the upper display.
3.	PV  SV 	When  key is pressed, the lower display flashes.	4.	PV  SV 	Press  key or  key to select auto tuning execution or not.
5.	PV  SV 	Press  key to store new value of AT.	When auto tuning AT LED lamp lit and start to output, through a few circles to get new PID value with the precise control, if finished the AT LED will be lamp off.		

## 10.5 PID value setting













1.	PV  SV 	Operation panel display.	2.	PV  SV 	Hold <b>SET</b> key 3 seconds, then the controller will enter LEVEL_2 upper display show "P1" lower display show current P1 value.
3.	PV  SV 	When <b>&lt;&lt;</b> key is pressed, the lower display flashes.	4.	PV  SV 	Press <b>⇩</b> key and <b>⇧</b> key to set the desire P1 value.
5.	PV  SV 	Press <b>SET</b> key to store new value of P1.	Similarly, use the same ways to set integral value(I1) and derivative value(D1).		

※ : Press SHIFT key the upper display will show PV value, this function can let user easy to monitor PV and this parameter relationship.









## 10.6 ON/OFF control setting

1.	PV  SV 	Operation panel display.	2.	PV  SV 	Hold <b>SET</b> key 3 seconds, then the controller will enter LEVEL_2 upper display show "P1" lower display show current P1 value.
3.	PV  SV 	When <b>&lt;&lt;</b> key is pressed, the lower display flashes, upper display will show current PV value.	4.	PV  SV 	Press <b>⇩</b> key until P1 = on.oF (0.0)
5.	PV  SV 	Press <b>SET</b> key to store new value.	6.	PV  SV 	Press <b>SET</b> key to get parameter setup display, "HYO1" shown on the upper display.
7.	PV  SV 	When <b>&lt;&lt;</b> key is pressed, the lower display flashes.	8.	PV  SV 	Press <b>⇩</b> key and <b>⇧</b> key to set the desire HYO1 value.
9.	PV  SV 	Press <b>SET</b> key to store new value.	Heat mode formula: $PV \geq (SV + HYO1) \rightarrow OUT1 \text{ OFF}$ $PV \leq (SV - HYO1) \rightarrow OUT1 \text{ ON}$ Cool mode formula: $PV \geq (SV + HYO1) \rightarrow OUT1 \text{ ON}$ $PV \leq (SV - HYO1) \rightarrow OUT1 \text{ OFF}$		





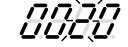











## 10.7 Alarm mode setting

1.	PV  SV 	Operation panel display.	2.	PV  SV 	Hold <b>SET</b> key + <b>&lt;&lt;</b> key 3 seconds, then the controller will enter LEVEL_3 upper display show "INP1" lower display show current input type.
3.	PV  SV 	Press <b>SET</b> key to get parameter setup display, "ALD1" shown on the upper display.	4.	PV  SV 	When <b>&lt;&lt;</b> SHIFT key is pressed, the lower display flashes.
5.	PV  SV 	Press <b>⇩</b> key and <b>⇧</b> key to set the desire ALD1 value.	6.	PV  SV 	Press <b>SET</b> key to store new value of ALD1. ※ Please refer to ch16.1 Alarm mode.

## 10.8 Alarm value setting

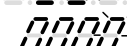
1.	PV  SV 	Operation panel display.	2.	PV  SV 	Press <input type="button" value="SET"/> key to get parameter setup display, "AL1H" shown on the upper display.
3.	PV  SV 	When <input type="button" value="←"/> key is pressed, the lower display flashes.	4.	PV  SV 	Press <input type="button" value="↓"/> key and <input type="button" value="↑"/> key to set the desire AL1H value.
5.	PV  SV 	Press <input type="button" value="SET"/> key to store new value of AL1H.			

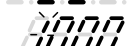
## 10.9 Manual mode selection

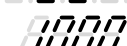
1.	PV  SV 	Operation panel display.	2.	PV  SV 	Press <input type="button" value="SET"/> key to get parameter setup display, "A-M" shown on the upper display.
3.	PV  SV 	When <input type="button" value="←"/> key is pressed, the lower display flashes.	4.	PV  SV 	Press <input type="button" value="↓"/> key or <input type="button" value="↑"/> key to select Auto/Man mode.
5.	PV  SV 	Press <input type="button" value="SET"/> key to store new value of A-M.	6.	PV  SV 	Press <input type="button" value="SET"/> key to get parameter setup display, "MOP" shown on the upper display.
7.	PV  SV 	When <input type="button" value="←"/> key is pressed, the lower display flashes.	8.	PV  SV 	Press <input type="button" value="←"/> key to choose digit and pressing <input type="button" value="↓"/> key and <input type="button" value="↑"/> key to set the desire value.
9.	PV  SV 	Press <input type="button" value="SET"/> key to store new value of MOP.	In manual mode MOP=100.0 output=100.0% continuous		

※ : SET8.2=1 (Show A-M & MOP parameter)

## 11. Flow chart of parameters setting

### 11.1 Levels operation mode

1. LEVEL 1 enter to the LEVEL 2  
Press and hold SET key for 3 seconds then enter to LEVEL 2
2. LEVEL 1 enter to the LEVEL 3  
Press and hold SET key + press SHIFT key for 3 seconds then enter to LEVEL 3
3. LEVEL 1 enter to the LEVEL 4  
Press and hold SET key for 3 seconds then enter to LEVEL 2 in LEVEL 2  
press SET key to find parameter "LCK" , modify LCK value from current value to 1111  
then Press and hold SET key + press SHIFT key for 3 seconds enter to LEVEL 4
4. LEVEL 2 return to the LEVEL 1  
Press and hold SET key for 3 seconds then return to LEVEL 1
5. LEVEL 3 return to the LEVEL 1  
Press and hold SET key + press SHIFT key for 3 seconds then return to LEVEL 1
6. LEVEL 4 return to the LEVEL 1  
Press and hold SET key + press SHIFT key for 3 seconds then return to LEVEL 1

### 11.2 Levels operation diagram

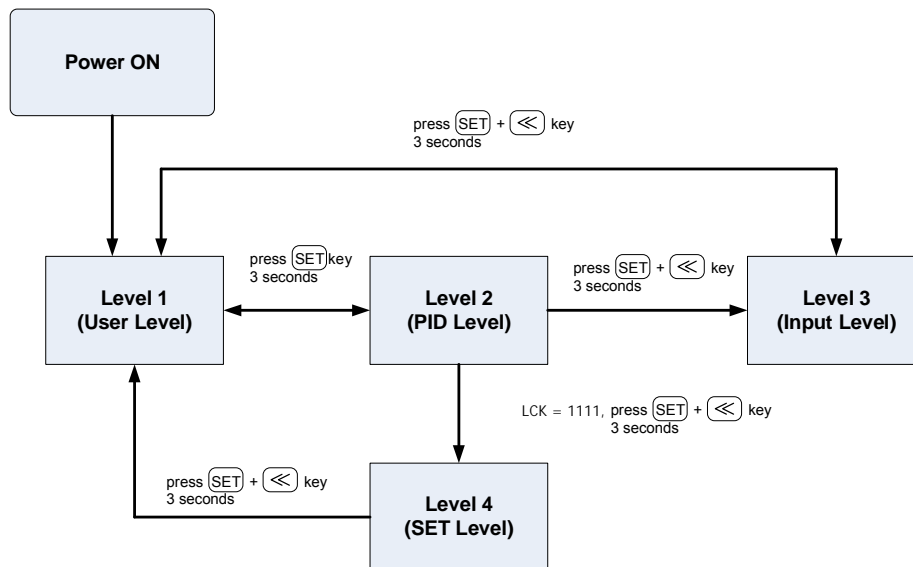

※ : This instrument returns to the PV/SV display mode if no key operation is performed for more than one minute.

### 11.3 Data lock (LCK) function

Lock and protect set data of parameters. this function avoid the important parameters to being changed by operator during operation. If parameter cannot be changed check the LCK setting value first.

LCK-function table

LCK	LEVEL				Remark
	Level_1	Level_2	Level_3	Level_4	
0000	◎	◎	◎	X	modify LEVEL_1_2_3 parameter available (initial)
1111	◎	◎	X	◎	modify LEVEL_1_2_4 parameter available
0110	◎	◎	X	X	modify LEVEL_1 parameter available
0001	◎	◎	X	X	only approval modify parameter SV · LCK
0011	◎	◎	X	X	only approval modify parameter SV · LCK · R-S
0101	◎	◎	X	X	only approval modify parameter LCK

◎ : approval    X : inhibit

## 11.4 Level 1 (User Level) all parameters display

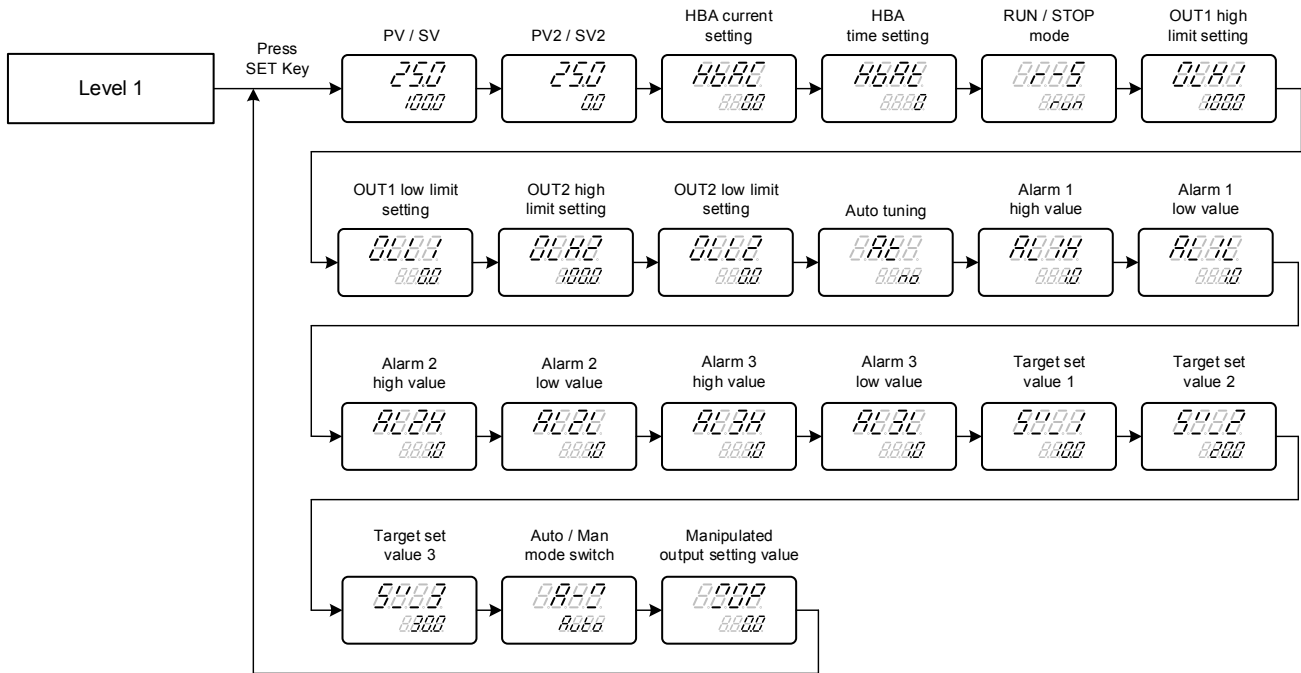

※ : This instrument returns to the PV/SV display mode if no key operation is performed for more than one minute.

## 11.5 Level 2 (PID Level) all parameters display

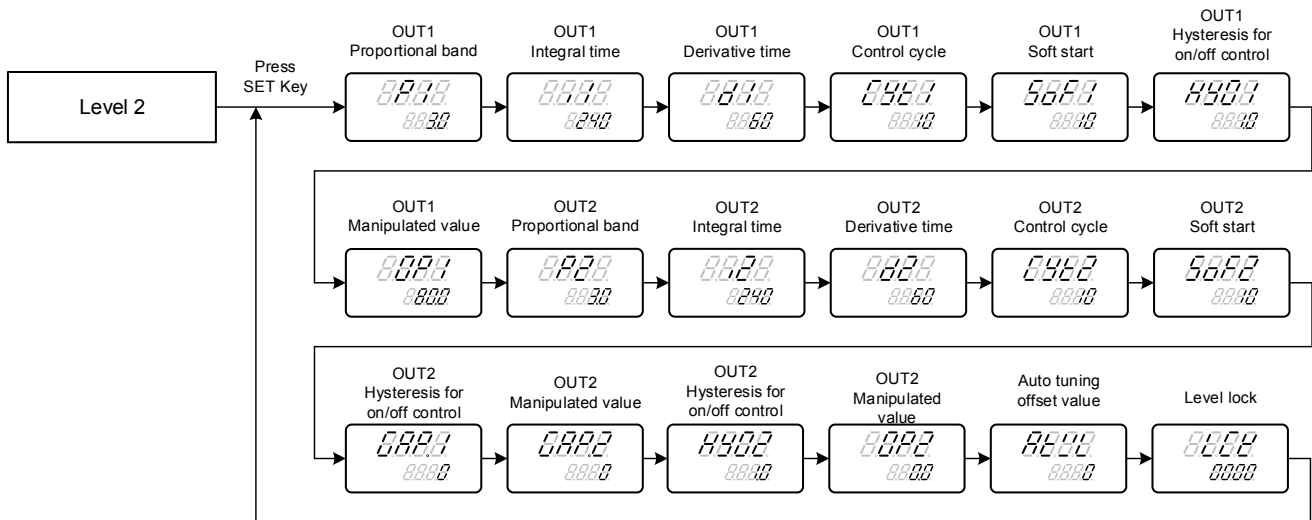

※ : This instrument returns to the PV/SV display mode if no key operation is performed for more than one minute.

## 11.6 Level 3 (Input Level) all parameters display

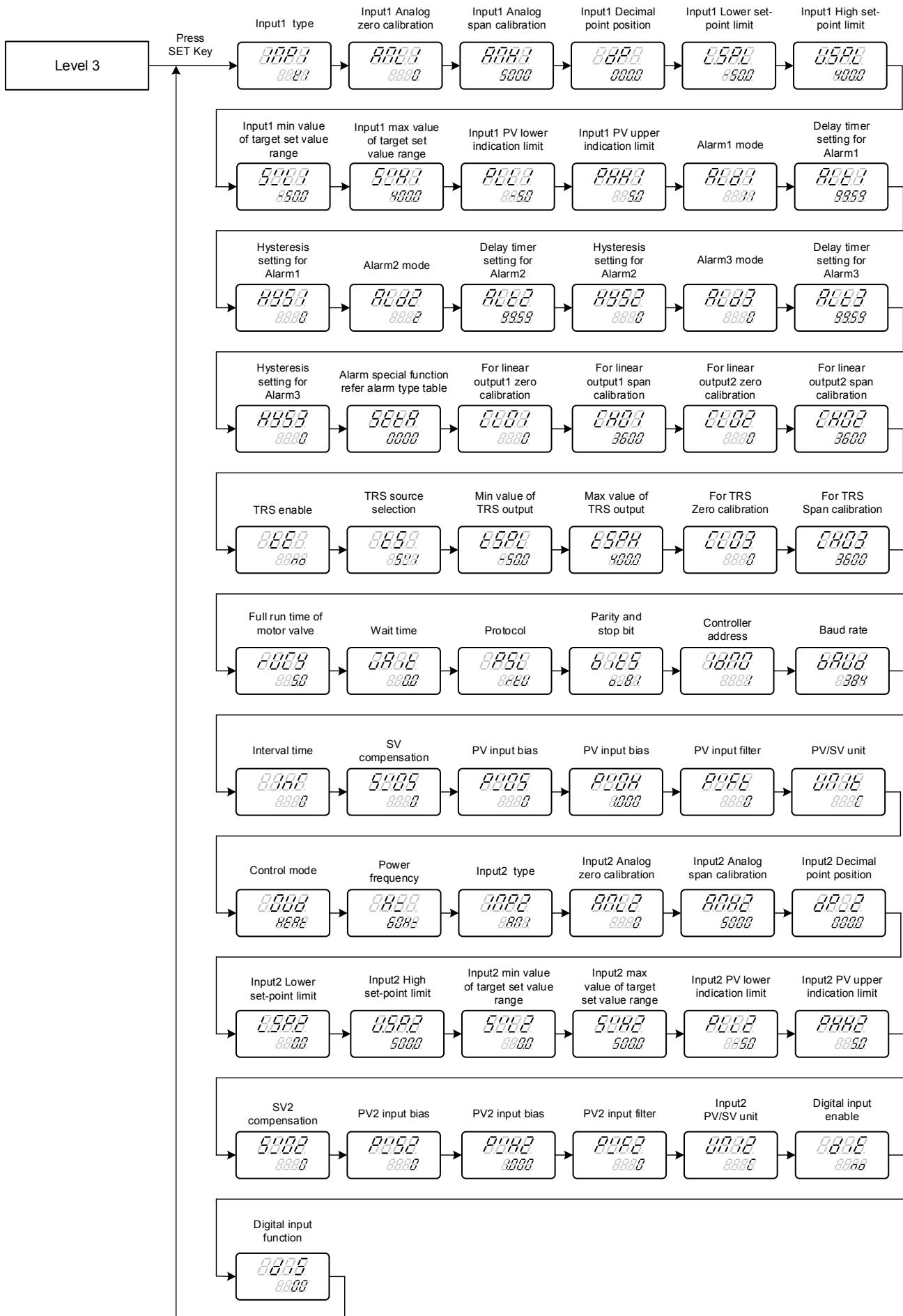

※ : This instrument returns to the PV/SV display mode if no key operation is performed for more than one minute.



## 11.7 Level 4 (Setting Level) all parameters display

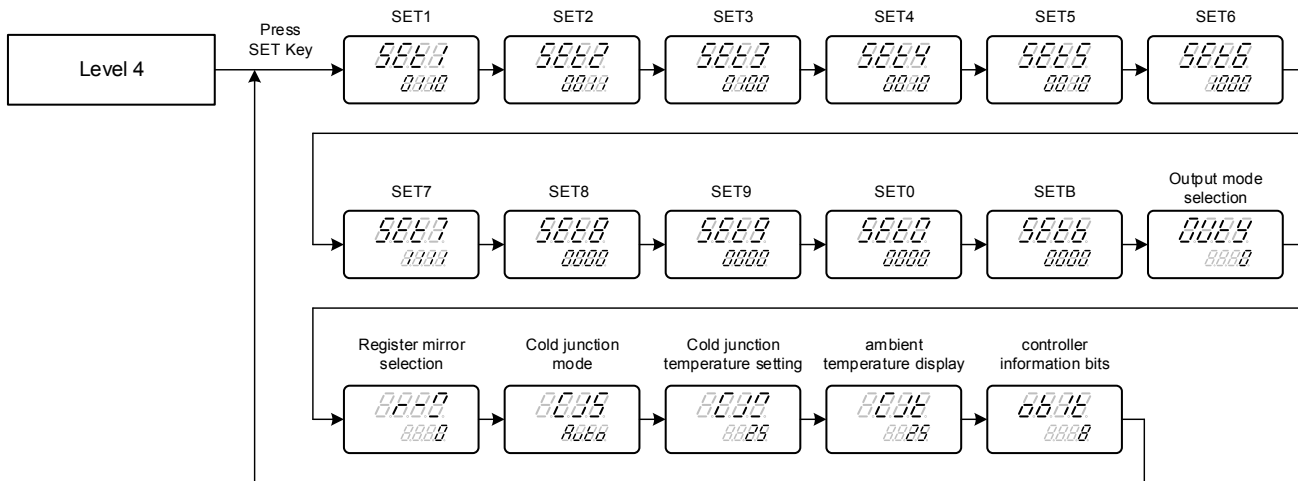

※ : This instrument returns to the PV/SV display mode if no key operation is performed for more than one minute.

## 12. Troubleshooting

If the controller displays one of the following, carry out the appropriate remedy for the particular error.

LED	Error	Solution
	INIE: Input1 Error	Check whether input loop is opened or wiring incorrect.
	UUU1: PV is above USPL	Check whether the input value is correct or not.
	NNN1: PV is below LSPL	Check whether the input value is correct or not.

If any of the indication in the table below appear, the controller need to be repaired do not try to repair the controller by yourself, order a new one or contact us to repair.

LED	Error	Solution
	ADCF: A/D convert failed	Send back repair.
	CJCE: Cold junction compensation failed	Send back repair.
	RAMF: EEPROM failed	Send back repair.

### 13. Parameters hide / display table on Level 4

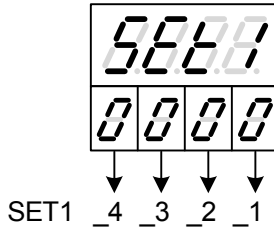

5888	SET1_1	0	hide	HBAC HBAT
		1	display	HBAC HBAT
	SET1_2	0	hide	R-S
		1	display	R-S
	SET1_3	0	hide	OLH1 OLL1
		1	display	OLH1 OLL1
	SET1_4	0	hide	OLH2 OLL2
		1	display	OLH2 OLL2
5888	SET2_1	0	hide	AT
		1	display	AT
	SET2_2	0	hide	AL1H AL1L
		1	display	AL1H AL1L
	SET2_3	0	hide	AL2H AL2L
		1	display	AL2H AL2L
	SET2_4	0	hide	AL3H AL3L
		1	display	AL3H AL3L
5888	SET3_1	0	hide	SV_1 SV_2 SV_3
		1	display	SV_1 SV_2 SV_3
	SET3_2	0	hide	ANL1 ANH1 DP
		1	display	ANL1 ANH1 DP
	SET3_3	0	hide	LSPL USPL
		1	display	LSPL USPL
	SET3_4	0	hide	SVL1 SVH1
		1	display	SVL1 SVH1
5888	SET4_1	0	hide	PLL1 PHH1
		1	display	PLL1 PHH1
	SET4_2	0	hide	ALD1 ALT1 HYS1
		1	display	ALD1 ALT1 HYS1
	SET4_3	0	hide	ALD2 ALT2 HYS2
		1	display	ALD2 ALT2 HYS2
	SET4_4	0	hide	ALD3 ALT3 HYS3
		1	display	ALD3 ALT3 HYS3
5888	SET5_1	0	hide	SETA
		1	display	SETA
	SET5_2	0	hide	CLO1 CHO1
		1	display	CLO1 CHO1
	SET5_3	0	hide	CLO2 CHO2
		1	display	CLO2 CHO2
	SET5_4	0	hide	TE TS TSPL TSPH CLO3 CHO3
		1	display	TE TS TSPL TSPH CLO3 CHO3

<i>5000</i>	SET6_1	0	hide	RUCY WAIT
		1	display	RUCY WAIT
	SET6_2	0	hide	PSL IDNO BITS BAUD INT
		1	display	PSL IDNO BITS BAUD INT
	SET6_3	0	hide	SVOS
		1	display	SVOS
	SET6_4	0	hide	PVOS PVOH
		1	display	PVOS PVOH

<i>5000</i>	SET7_1	0	hide	PVFT
		1	display	PVFT
	SET7_2	0	hide	UNIT
		1	display	UNIT
	SET7_3	0	hide	OULD
		1	display	OULD
	SET7_4	0	hide	HZ
		1	display	HZ

<i>5000</i>	SET8_1	0	hide	DIE DIS
		1	display	DIE DIS
	SET8_2	0	hide	A-M MOP
		1	display	A-M MOP
	SET8_3	0	hide	reserve ,do not care
		1	display	reserve ,do not care
	SET8_4	0	hide	reserve ,do not care
		1	display	reserve ,do not care

<i>5000</i>	SET9_1	0	Channel 2 input disable
		1	Channel 2 input enable
	SET9_2	0	Channel 1 analog input reverse display disable
		1	Channel 1 analog input reverse display enable
	SET9_3	0	Channel 2 analog input reverse display disable
		1	Channel 2 analog input reverse display enable
	SET9_4	0	register mirror disable
		1	register mirror enable

<i>5000</i>	SET0_1	0	power – on soft start disable
		1	power – on soft start enable
	SET0_2	0	hot runner disable
		1	hot runner enable
	SET0_3	0	Remote SV disable
		1	Remote SV enable
	SET0_4	0	reserve ,do not care
		1	reserve ,do not care

## 14. List of parameters

### 14.1 COMM GROUP

Parameter	LED	Content	Range		Initial	Level
			MAX	MIN		
PSL	8850	Protocol selection 0: TAIE 1: Modbus RTU	1	0	Modbus RTU	Level 3
BITS	8885	Parity and stop bit 0: O_81 1: O_82 2: E_81 3: E_82 4: N_81 5: N_82	5	0	O_81	Level 3
IDNO	8800	Controller address	255	0	1	Level 3
BAUD	8808	Baudrate 0: 2400 1: 4800 2: 9600 3: 19200 4: 38400 5: 57600 6: 115200	6	0	38400	Level 3
INT	8888	Interval time (ms) Use for data response delay	250	0	0	Level 3
R-M	8888	Register mirror selection	10	0	0	Level 4

### 14.2 DI GROUP

Parameter	LED	Content	Range		Initial	Level
			MAX	MIN		
DIE	8888	Digital input enable 0: NO (disable) 1: YES (enable)	1	0	NO	Level 3
DIS	8885	Digital input function Please refer to ch15.1.	9999	0000	0000	Level 3

### 14.3 ALARM GROUP

Parameter	LED	Content	Range		Initial	Level
			MAX	MIN		
AL1H	8888	Alarm value upper limit 1	9999	-1999	10	Level 1
AL1L	8888	Alarm value lower limit 1	9999	-1999	10	Level 1
AL2H	8888	Alarm value upper limit 2	9999	-1999	10	Level 1
AL2L	8888	Alarm value lower limit 2	9999	-1999	10	Level 1
AL3H	8888	Alarm value upper limit 3	9999	-1999	10	Level 1
AL3L	8888	Alarm value lower limit 3	9999	-1999	10	Level 1
ALD1	8888	Alarm1 mode selection	25	0	11	Level 3
ALD2	8888	Alarm2 mode selection	25	0	2	Level 3
ALD3	8888	Alarm3 mode selection	25	0	0	Level 3
ALT1	8888	00.00: Flicker 99.59: Continued ON 00.01~99.58: delay time	99.59	00.00	99.59	Level 3
ALT2	8888		99.59	00.00	99.59	Level 3
ALT3	8888		99.59	00.00	99.59	Level 3
HYS1	8858	Hysteresis setting for alarm1	1000	0	0	Level 3
HYS2	8858	Hysteresis setting for alarm2	1000	0	0	Level 3
HYS3	8858	Hysteresis setting for alarm3	1000	0	0	Level 3
SETA	5888	Alarm special function Please refer to ch16.2 .	1111	0000	0000	Level 3

## 14.4 PID GROUP

Parameter	LED	Content	Range		Initial	Level
			MAX	MAX		
※ P1	8888	OUT1 Proportional band 0 : 8888 ON/OFF control 0.1~200.0 : PID control	200.0	0.0	3.0	Level 2
※ I1	8888	OUT1 Integral time	3600	0	240	Level 2
※ D1	8888	OUT1 Derivative time	2400	0	60	Level 2
CYT1	8888	OUT1 Control cycle 0 : 8888 Linear signal 1 : 8558 SSR drive 2~150 : Relay	150	0	10	Level 2
GAP.1	8888	Control gap 1 (for output 1)	1000	0	0	Level 2
※ P2	8888	OUT2 Proportional band 0 : 8888 ON/OFF control 0.1~200.0 : PID control	200.0	0.0	3.0	Level 2
※ I2	8888	OUT2 Integral time	3600	0	240	Level 2
※ D2	8888	OUT2 Derivative time	2400	0	60	Level 2
CYT2	8888	OUT2 Control cycle 0 : 8888 Linear signal 1 : 8558 SSR drive 2~150 : Relay	150	0	10	Level 2
GAP.2	8888	Control gap 2 (for output 2)	1000	0	0	Level 2
HYO1	8800	Hysteresis for OUT1 on/off control	1000	0	1	Level 2
HYO2	8800	Hysteresis for OUT2 on/off control	1000	0	1	Level 2

※ : Press SHIFT key the upper display will show PV value, this function can let user easy to monitor PV with this parameter effect.

## 14.5 SV GROUP

Parameter	LED	Content	Range		Initial	Level
			MAX	MIN		
SV	8888	Local set value for input1	SVH1	SVL1	0	Level 1
SV2	8888	Local set value for input2	SVH2	SVL2	0	Level 1
SV-1	5000	Target set value 1	SVH1	SVL1	0	Level 1
SV-2	5000	Target set value 2	SVH1	SVL1	0	Level 1
SV-3	5000	Target set value 3	SVH1	SVL1	0	Level 1
SVL1	5000	Minimum value of target set value range for input1	USPL	LSPL	LSPL	Level 3
SVH1	5000	Maximum value of target set value range for input1	USPL	LSPL	USPL	Level 3
SVL2	5000	Minimum value of target set value range for input2	USP2	LSP2	LSP2	Level 3
SVH2	5000	Maximum value of target set value range for input2	USP2	LSP2	USP2	Level 3
SVOS	5000	SV compensation	5000	-1000	0	Level 3
SVO2	5000	SV2 compensation	5000	-1000	0	Level 3

## 14.6 AT GROUP

Parameter	LED	Content	Range		Initial	Level
			MAX	MIN		
AT	8888	Auto-tuning 0: 8888 1: 8888	1	0	NO	Level 1
ATVL	8888	Auto tuning offset value	USPL	0	0	Level 2

## 14.7 SYSTEM GROUP

Parameter	LED	Content	Range		Initial	Level
			MAX	MIN		
LCK	8888	Function lock Please refer to "LCK-function table"	1111	0000	0000	Level 2
UNIT	0000	Temperature unit 0: 8888 °C 1: 8888 °F 2: 8888 Linear signal	2	0	C	Level 3
HZ	8888	Power frequency 0: 5088 50HZ 1: 5088 60HZ	1	0	60HZ	Level 3
UNI2	0000	Temperature unit 0: 8888 °C 1: 8888 °F 2: 8888 Linear signal	2	0	C	Level 3
OBIT	8888	Communication bits configuration Bit_0 : OUT1 Bit_1 : OUT2 Bit_2 : AT Bit_3 : AL1 Bit_4 : AL2 Bit_5 : AL3 Bit_6 : COM Bit_7 : MAN Bit_8 : INIE Bit_9 : ADCF Bit_10 : CJCE Bit_11 : IN2E Bit_12 : UUU1 Bit_13 : NNN1 Bit_14 : UUU2 Bit_15 : NNN2	---	---	---	Level 4
CJS	8888	Cold junction mode selection 0: 8888 Automatic compensation 1: 8888 Manual compensation	1	0	Auto	Level 4
CJM	8888	Cold junction temperature setting	50	0	25	Level 4
CJT	8888	Ambience temperature display	---	---	---	Level 4

## 14.8 CONTROL GROUP

Parameter	LED	Content	Range		Initial	Level
			MAX	MIN		
R-S	8888	Run/stop mode 0: 5668 Output stop 1: 8888 Output enable	1	0	RUN	Level 1
OLH1	0000	High limit setting of manipulated value for output1	100.0	0.0	100.0	Level 1
OLL1	0000	low limit setting of manipulated value for output1	100.0	0.0	0.0	Level 1
OLH2	0000	High limit setting of manipulated value for output2	100.0	0.0	100.0	Level 1
OLL2	0000	low limit setting of manipulated value for output2	100.0	0.0	0.0	Level 1
A-M	8888	Auto/Man mode switch 0: 8888 Automatic 1: 0000 Manual	1	0	Auto	Level 1
MOP	8000	Manipulated output setting value	100.0	0.0	0.0	Level 1
SOF1	5888	Power-ON soft start function for output1	5000	5	10	Level 2
OP1	8000	Manipulated value for output1	100.0	0.0	---	Level 2
SOF2	5888	Power-ON soft start function for output2	5000	5	10	Level 2
OP2	8000	Manipulated value for output2	100.0	0.0	---	Level 2
※ CLO1	0000	output1 zero calibration only for linear signal	9999	0	0	Level 3
※ CHO1	0000	output1 span calibration only for linear signal	9999	0	3600	Level 3
※ CLO2	0000	Output2 zero calibration only for linear signal	9999	0	0	Level 3
※ CHO2	0000	Output2 span calibration only for linear signal	9999	0	3600	Level 3
OUT	8000	Control mode 0 : 8888 Heating mode 1 : 0000 Cooling mode	1	0	HEAT	Level 3

※ : Each controller calibration values are different, before the modify please record the current value.

## 14.9 INPUT GROUP

Parameter	LED	Content	Range		Initial	Level
			MAX	MIN		
PV	---	Process value for input1	USPL	LSPL	---	Level 1
PV2	---	Process value for input2	USP2	LSP2	---	Level 1
INP1	8888	Input1 type selection Please refer to ch4 Input range table	19	1	1	Level 3
※ ANL1	8888	Analog input zero calibration for input1 Please refer to ch18.4 Input calibration flowchart	9999	-1999	0	Level 3
※ ANH1	8888	Analog input span calibration for input1 Please refer to ch18.4 Input calibration flowchart	9999	-1999	5000	Level 3
DP	8888	Decimal point position for input1 0: 0000 1: 000.0 2: 00.00 3: 0.000	3	0	1	Level 3
LSPL	8888	Minimum value of measured input1 scale	9999	-1999	---	Level 3
USPL	8888	Maximum value of measured input1 scale	9999	-1999	---	Level 3
PLL1	8888	PV lower indication limit for input1 PV<(LSPL+PLL1)=>show under range error message	9999	-1999	-5.0	Level 3
PHH1	8888	PV upper indication limit for input1 PV>(USPL+PHH1)=>show over range error message	9999	-1999	5.0	Level 3
※ PVOS	8888	PV input1 bias(for zero) PV=(PVxPVOH)+PVOS	5000	-1000	0	Level 3
※ PVOH	8888	PV input1 bias(for span) PV=(PVxPVOH)+PVOS	9.999	0.000	1.000	Level 3
PVFT	8888	Is used to eliminate noise against the measure input1 0 : 8888 : no filter 0.1~10.0 : digital filter	10.0	0.0	0.0	Level 3
INP2	8888	Input2 type selection Please refer to ch4 Input range table	19	1	1	Level 3
※ ANL2	8888	remote input zero calibration for input2	9999	-1999	0	Level 3
※ ANH2	8888	remote input span calibration for input2	9999	-1999	5000	Level 3
DP_2	8888	Decimal point position for input2 0: 0000 1: 000.0 2: 00.00 3: 0.000	3	0	1	Level 3
LSP2	8888	Minimum value of measured input2 scale	9999	-1999	---	Level 3
USP2	8888	Maximum value of measured input2 scale	9999	-1999	---	Level 3
PLL2	8888	PV2 lower indication limit for input2 PV2<(LSP2-PLL2)=>show under range error message	9999	-1999	-5.0	Level 3
PHH2	8888	PV2 upper indication limit for input2 PV2>(USP2+PHH2)=>show over range error message	9999	-1999	5.0	Level 3
※ PVS2	8888	PV input2 bias(for zero) PV2=(PV2xPVH2)+PVS2	5000	-1000	0	Level 3
※ PVH2	8888	PV input2 bias(for span) PV2=(PV2xPVH2)+PVS2	9.999	0.000	1.000	Level 3

※ : Press SHIFT key the upper display will show PV/PV2 value, this function can let user easy to monitor PV with this parameter effect.



## 14.9 INPUT GROUP

Parameter	LED	Content	Range		Initial	Level
			MAX	MIN		
PVF2	<i>8888</i>	Is used to eliminate noise against the measure input2 0 : <i>8888</i> : no filter 0.1~10.0 : digital filter	10.0	0.0	0.0	Level 3

※ : Press SHIFT key the upper display will show PV/PV2 value, this function can let user easy to monitor PV with this parameter effect.

## 14.10 TRANSMISSION GROUP

Parameter	LED	Content	Range		Initial	Level
			MAX	MIN		
TE	<i>8888</i>	Transmission function enable 0: <i>8888</i> (disable) 1: <i>8888</i> (enable)	1	0	0	Level 3
TS	<i>8888</i>	Transmission output signal choose 0: SV1 1: PV1 2: PV2 3: OP1	3	0	0	Level 3
TSPL	<i>8888</i>	Minimum value of retransmission output	USPL	LSPL	LSPL	Level 3
TSPH	<i>8888</i>	Maximum value of retransmission output	USPL	LSPL	USPL	Level 3
※ CLO3	<i>0000</i>	For transmission zero calibration	9999	-1999	0	Level 3
※ CHO3	<i>0000</i>	For transmission span calibration	9999	-1999	3600	Level 3

※ : Refer to the transmission example.

FE series controller transmission function allows digital value PV1/PV2/SV1/OP1 parameters with analog signaled to an external device according to predetermined range. (TSPL ~ TSPH)

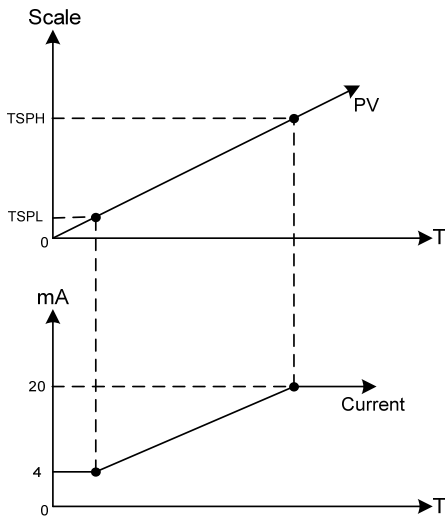

## 14.11 HBA GROUP

Parameter	LED	Content	Range		Initial	Level
			MAX	MIN		
HBAC	<i>8888</i>	HBA current setting unit : ampere(A)	100.0	0.0	0.0	Level 1
HBAT	<i>8888</i>	HBA disconnection set time unit : second(S)	100	0	5	Level 1

## 15. Digital input function

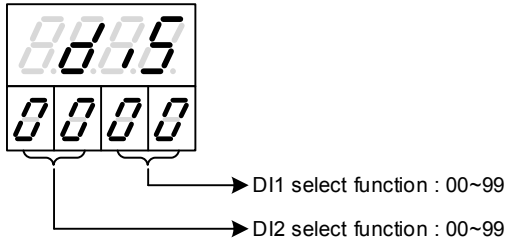

### 15.1 DIS mode table

DIS parameter is digital input mode selection, low byte of the first group DI1 mode setting, its range 00~99  
high byte of the second group DI2 mode setting, its range 00~99

Mode	DI1 ( XX00~XX99 )	DI2 (00XX~99XX )
00	Disable Digital Input function	
01	SV_1 write to SV	
02	SV_2 write to SV	
03	AT = YES / NO	
04	R-S = RUN / STOP	
05	Timer 1 = RUN / STOP	
	 ※ set ALD1 = 7 (timer mode)	

Mode	DI1 ( XX00~XX99 )	DI2 (00XX~99XX )
06	Timer 2 = RUN / STOP	
	 ※ set ALD2 = 7 (timer mode)	
07	Power saving = RUN / STOP	
08	Choose SV_1~SV_3 to write to SV , Please refer to DI for SV table	
09	SV & SV_1 toggle	

※ : Dry contact output rated open >500 KΩ or more, close <10Ω, sample time >10 ms.

## 15.2 DI for 3SV

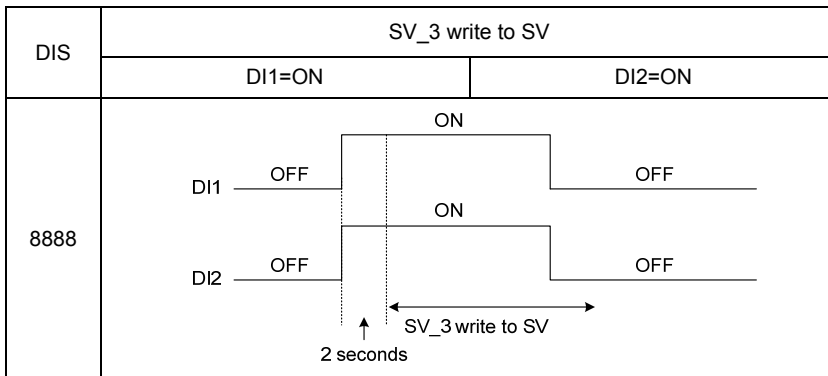
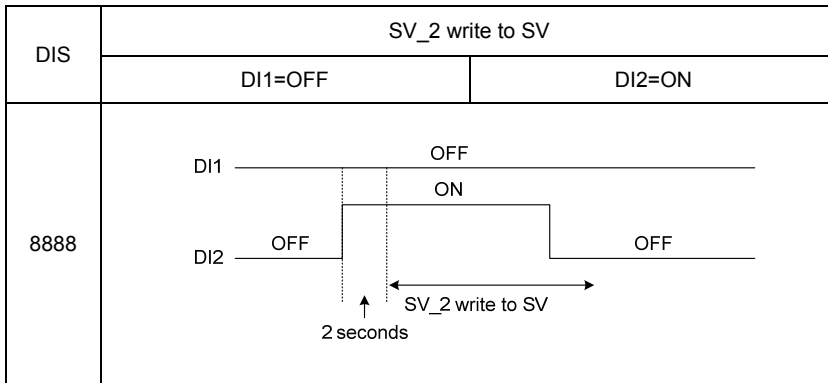
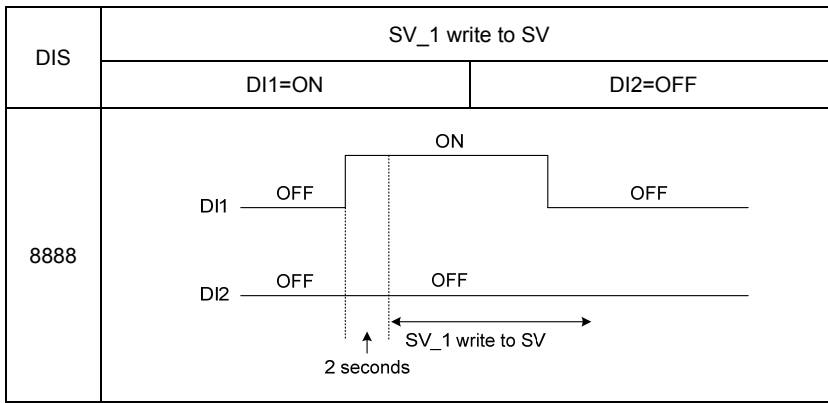

※ : Dry contact output rated open >500 K $\Omega$ , close <10 $\Omega$ , sample time >2 sec.

## 16. Alarm action explanation

### 16.1 Alarm mode

▲ : SV    △ : Alarm set value    X : 1 or 2

ALDX	Alarm type	Description
00	No alarm	Not drive any alarm relays and the corresponding LED lamp.
01	Deviation high With hold action	
11	Deviation high	Formula $PV > (SV + ALXH) \rightarrow \text{Alarm ON}$ $PV \leq (SV + ALXH - HYSX) \rightarrow \text{Alarm OFF}$
02	Deviation low With hold action	
12	Deviation low	Formula $PV < (SV + ALXL) \rightarrow \text{Alarm ON}$ $PV \geq (SV + ALXL + HYSX) \rightarrow \text{Alarm OFF}$
03	Deviation high/low With hold action	
13	Deviation high/low	Formula $PV < (SV - ALXL) \rightarrow \text{Alarm ON}$ $PV \geq (SV - ALXL + HYSX) \rightarrow \text{Alarm OFF}$ $PV > (SV + ALXH) \rightarrow \text{Alarm ON}$ $PV \leq (SV + ALXH - HYSX) \rightarrow \text{Alarm OFF}$
04	Band With hold action	
14	Band	Formula $PV \geq (SV - ALXL) \rightarrow \text{Alarm ON}$ $PV < (SV - ALXL) \rightarrow \text{Alarm OFF}$ $PV \geq (SV + ALXH) \rightarrow \text{Alarm ON}$ $PV > (SV + ALXH) \rightarrow \text{Alarm OFF}$
05	PV high With hold action	
15	PV high	Formula $PV > ALXH \rightarrow \text{Alarm ON}$ $PV \leq (ALXH - HYSX) \rightarrow \text{Alarm OFF}$
06	PV low With hold action	
16	PV low	Formula $PV < ALXL \rightarrow \text{Alarm ON}$ $PV \geq (ALXL + HYSX) \rightarrow \text{Alarm OFF}$

※ : With hold action

When hold action is ON, the alarm action is suppressed at start-up until measured value has entered the non-alarm range.

## 16.1 Alarm mode

▲ : SV    △ : Alarm set value , X : 1 or 2

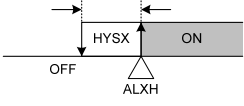
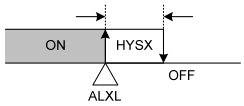
ALDX	Alarm mode	Description
07	Timer	(1) set ALXH = 1000 timer start counting , when timer count to ALTX setting value alarm action ON (2) set ALXH = 0 stop and reset timer ALTX="hour"." minute"
08	Error	when PV show error message alarm ON when PV show normal temperature alarm OFF
09	SV high	 Formula $SV > ALXH \rightarrow \text{Alarm ON}$ $SV \leq (ALXH - HYSX) \rightarrow \text{Alarm OFF}$
10	SV low	 Formula $SV < ALXL \rightarrow \text{Alarm ON}$ $SV \geq (ALXL + HYSX) \rightarrow \text{Alarm OFF}$

※ : With hold action

When hold action is ON, the alarm action is suppressed at start-up until measured value has entered the non-alarm range.

Ex: Process low alarm

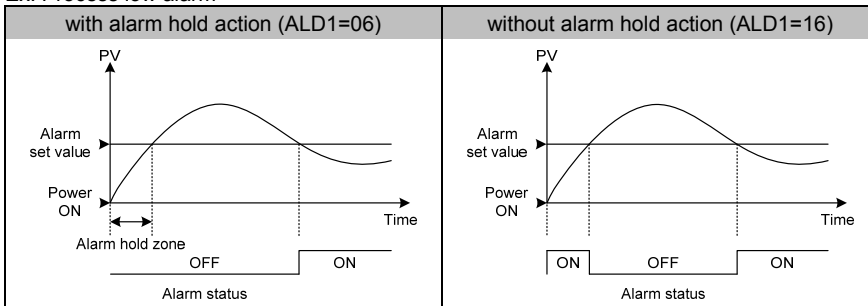

## 16.2 Alarm special function

### 1. Alarm Reverse Function

After power-on if no alarm events generate the alarm relay will contact in close condition  
if alarm events generate the alarm relay will contact in open condition.

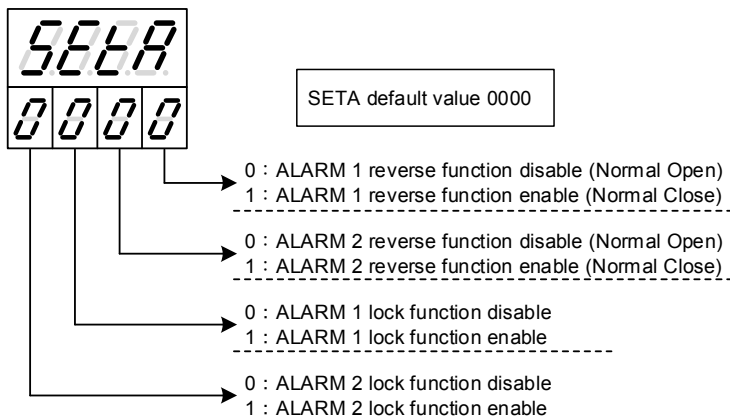

### 2. Alarm Lock Function

When alarm events generate the alarm relay contact and led indicator continuous will on  
even PV/SV return to normal band led still not release until power reset the contact.



## 17. Control module modification

### 17.1 RELAY Control

Top view	Side view	Software Setting
		Set the parameter "CYT1=10"

### 17.2 SSR Control

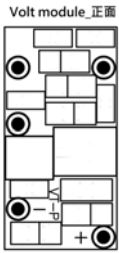
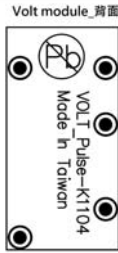
Top view	Bottom view	Software Setting
		Set the parameter "CYT1=SSr(1)"

### 17.3 Linear Control

※ : When modify linear module need to calibrate output signal, please refer to ch17.4 Output calibration flowchart.

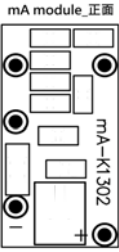
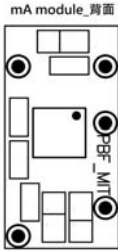
Top view	Bottom view	Software Setting
		Set the parameter "CYT1=LinE(0)"

## 17.4 Output calibration flowchart

### Output Signal (4mA~20mA) calibration flowchart

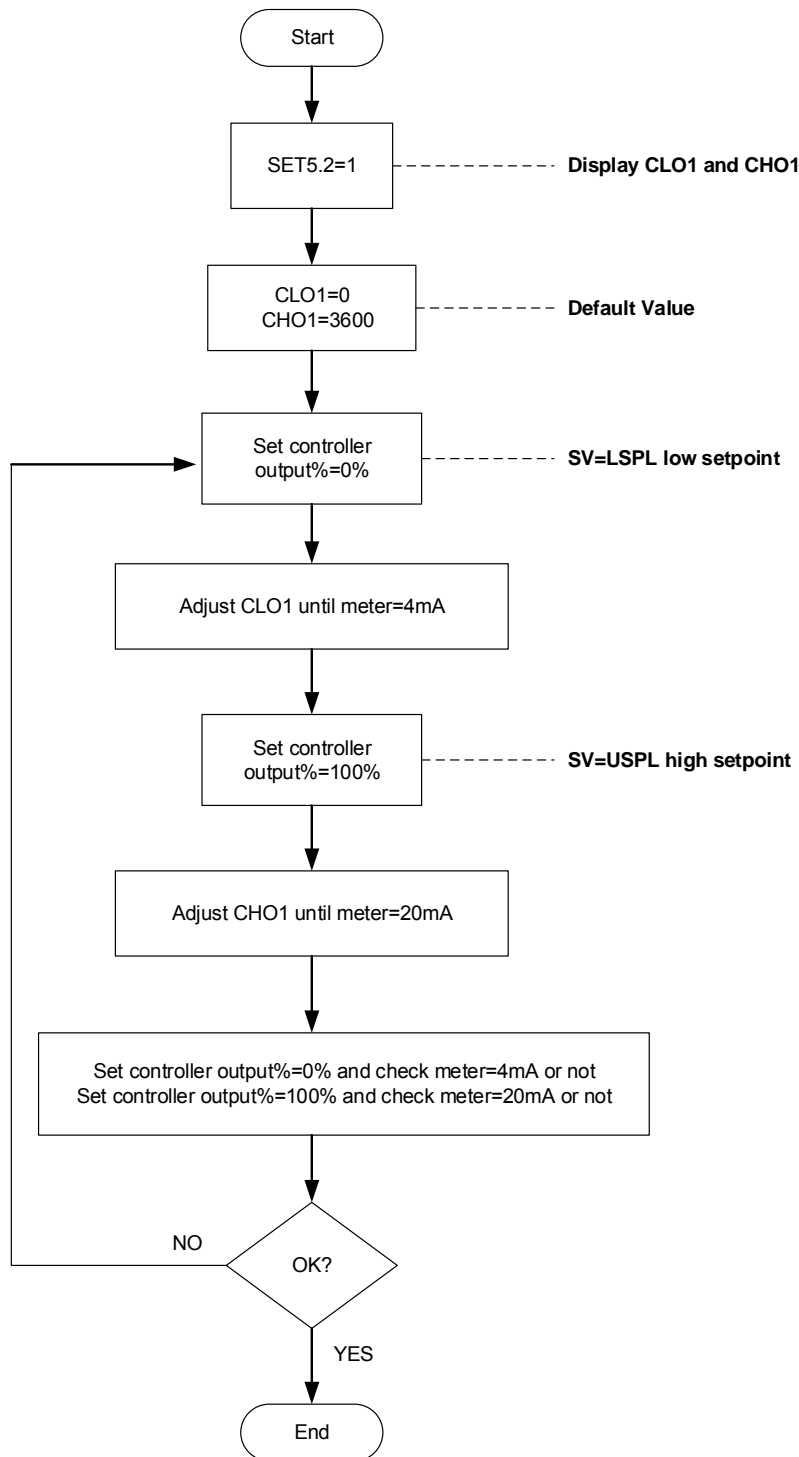

## 17.5 Output calibration steps

### 1. Display CLO1 & CHO1 :

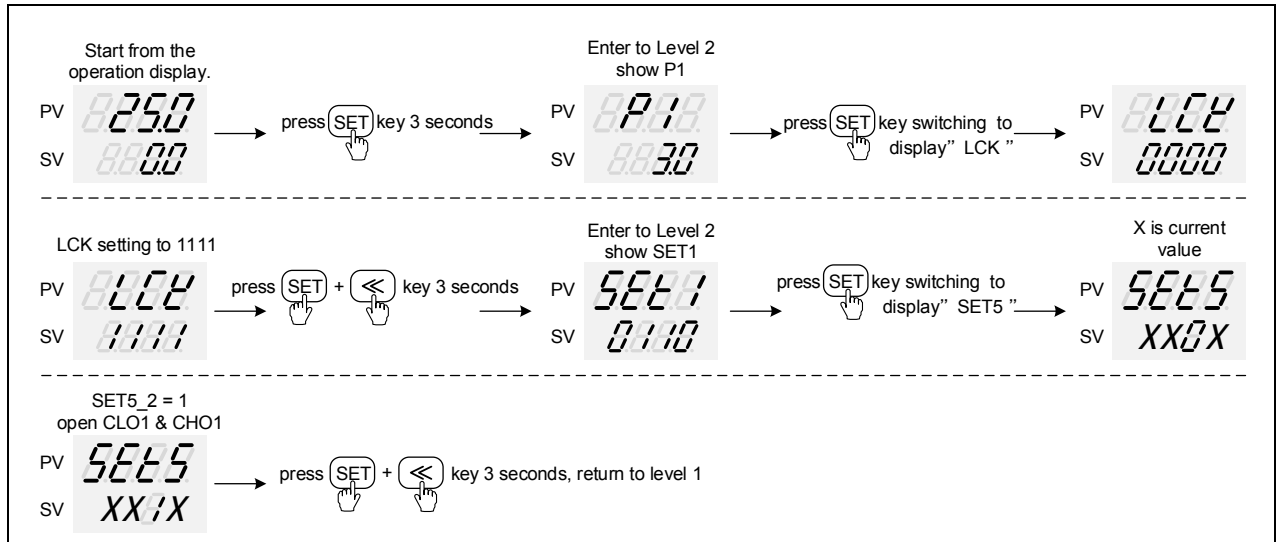

※ : X is current value

### 2. Adjust CLO1 value :

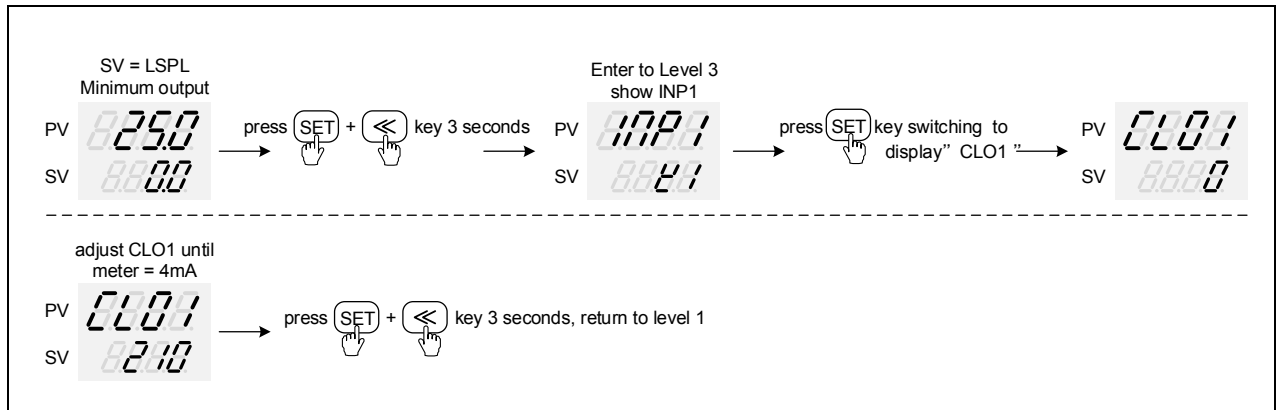

※ : Each controller CLO1 value is different.

### 3. Adjust CHO1 value :

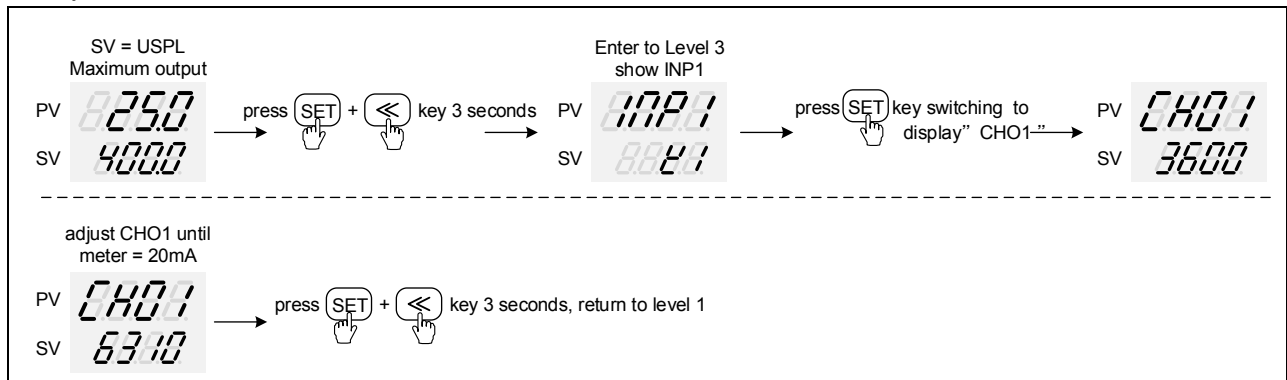

※ : Each controller CHO1 value is different.



## 18. Input type modification

### 18.1 Modify to Thermocouple

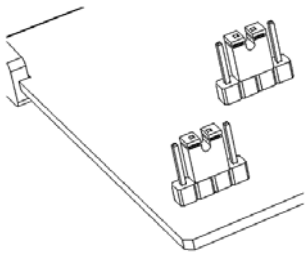
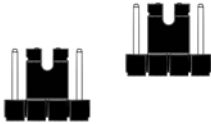
Jumper Address		Software Setting
Middle location		
		Set the parameter "INP1=K1~L"

### 18.2 Modify to RTD

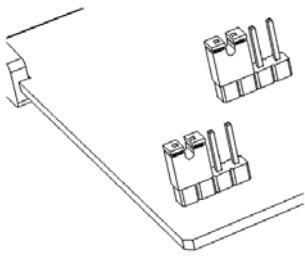
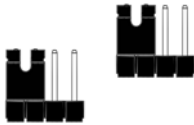
Jumper Address		Software Setting
Left location		
		Set the parameter "INP1=DP1~DP3"

### 18.3 Modify to Linear (4~20mA)

- ※ : 1. When modify input type to linear signal need to calibrate input signal, please refer to ch18.4 Input calibration flowchart  
 2. If want modify to other linear signal, please send it to the retail dealer.

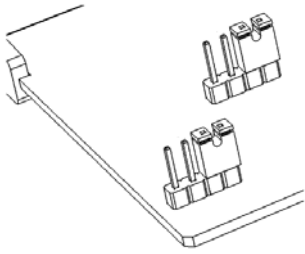
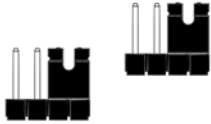
Jumper Address		Software Setting
Right location		
		Set the parameter "INP1=AN2"

## 18.4 Input calibration flowchart

### Input Signal (4mA~20mA) calibration flowchart

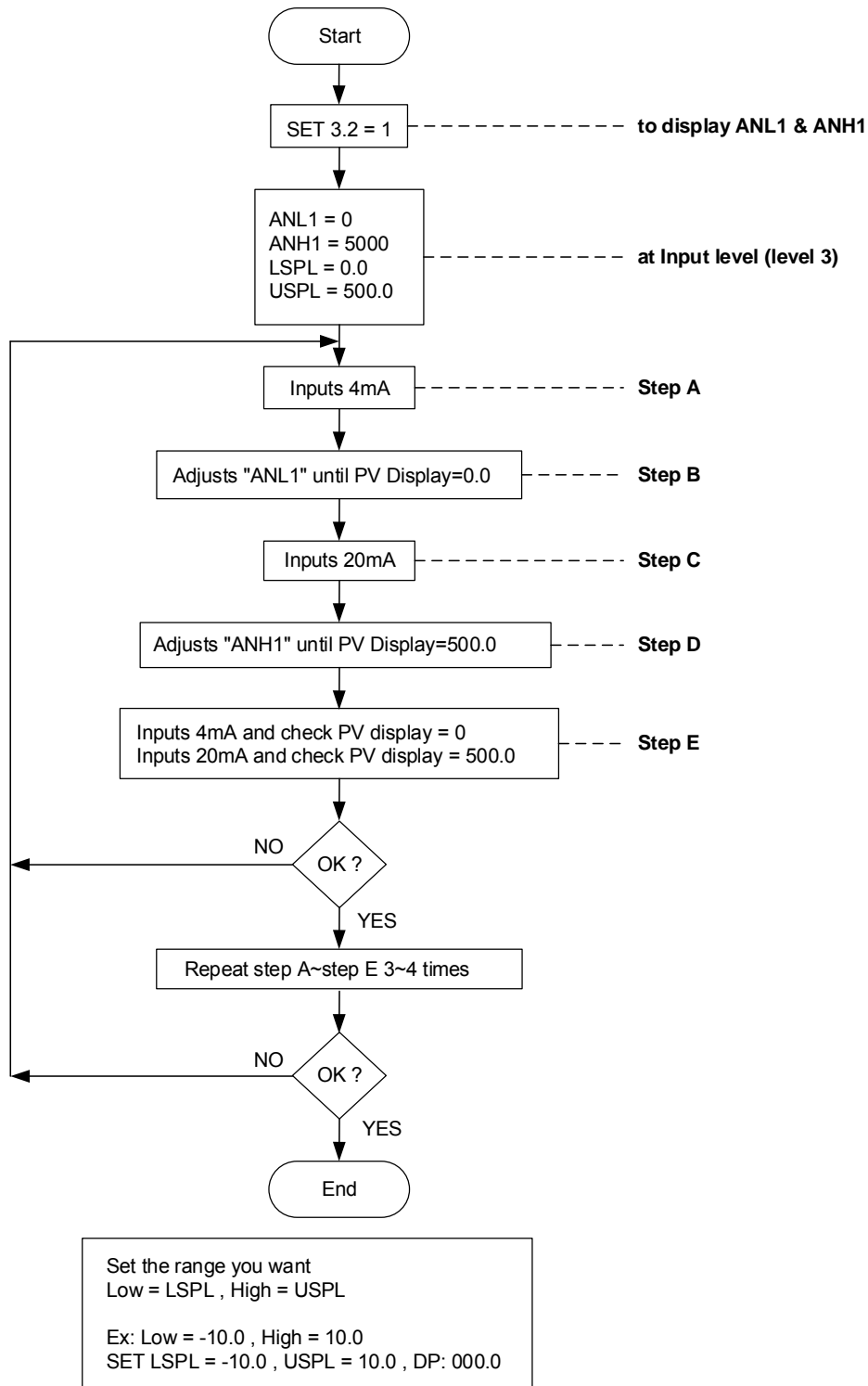

## 18.5 Input calibration steps

### 1. Display ANL1 & ANH1 :

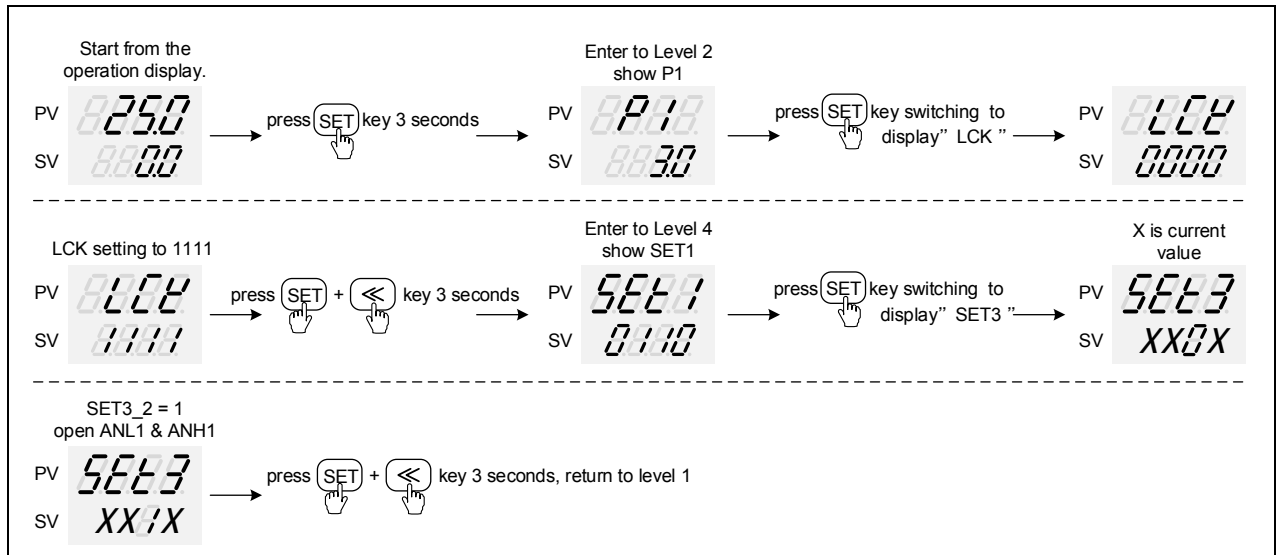

※ : X is current value

### 2. Adjust ANL1 value :

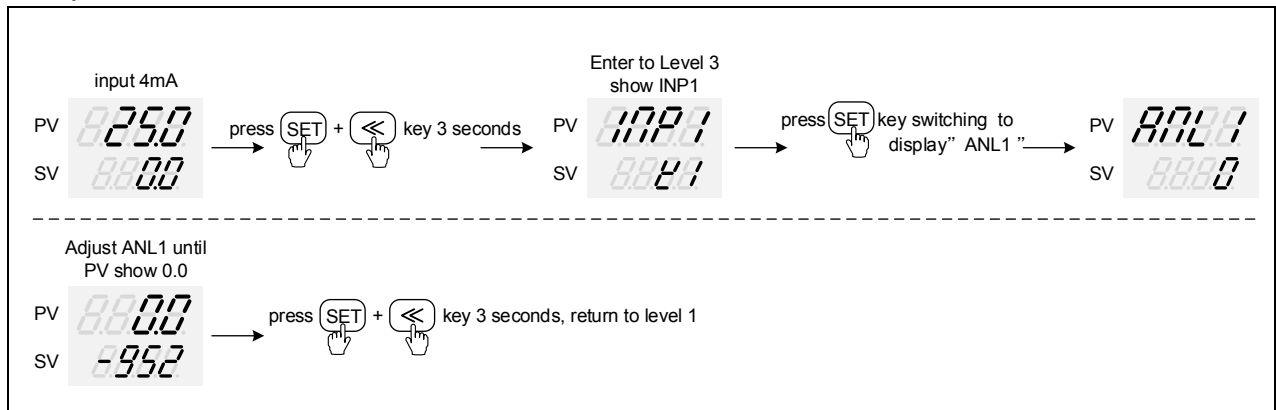

※ : Each controller ANL1 value is different.

### 3. Adjust ANH1 value :

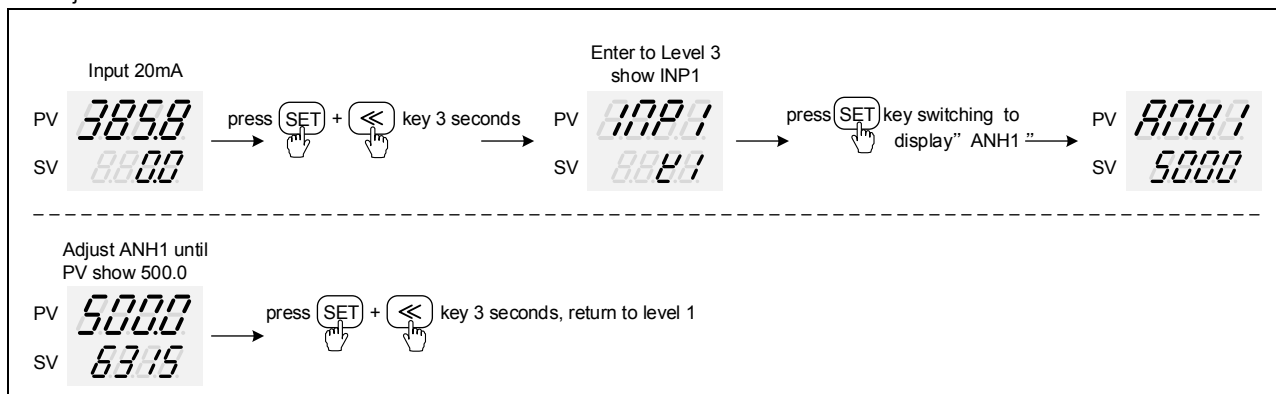

※ : Each controller ANH1 value is different.

## 19. Communication register address table

Parameter	Register Address		R / W
	Hex	Dec	
SV	0x00	0	R / W
PV	0x01	1	R
SV2	0x02	2	R / W
PV2	0x03	3	R
HBAC	0x04	4	R / W
HBAT	0x05	5	R / W
R-S	0x06	6	R / W
OLH1	0x07	7	R / W
OLL1	0x08	8	R / W
OLH2	0x09	9	R / W
OLL2	0x0A	10	R / W
AT	0x0B	11	R / W
AL1H	0x0C	12	R / W
AL1L	0x0D	13	R / W
AL2H	0x0E	14	R / W
AL2L	0x0F	15	R / W
AL3H	0x10	16	R / W
AL3L	0x11	17	R / W
SV_1	0x12	18	R / W
SV_2	0x13	19	R / W
SV_3	0x14	20	R / W
A-M	0x15	21	R / W
MOP	0x16	22	R / W
P1	0x35	53	R / W
I1	0x36	54	R / W
D1	0x37	55	R / W
CYT1	0x38	56	R / W
SOF1	0x39	57	R / W
HYO1	0x3A	58	R / W
OP1	0x3B	59	R
P2	0x3C	60	R / W
I2	0x3D	61	R / W
D2	0x3E	62	R / W
CYT2	0x3F	63	R / W
SOF2	0x40	64	R / W
GAP.1	0x41	65	R / W
GAP.2	0x42	66	R / W
HYO2	0x43	67	R / W
OP2	0x44	68	R
ATVL	0x45	69	R / W
LCK	0x4B	75	R / W
INP1	0x4C	76	R / W
ANL1	0x4D	77	R / W
ANH1	0x4E	78	R / W
DP	0x4F	79	R / W
LSPL	0x50	80	R / W
USPL	0x51	81	R / W
SVL1	0x52	82	R / W
SVH1	0x53	83	R / W
PLL1	0x54	84	R / W
PHH1	0x55	85	R / W
ALD1	0x56	86	R / W
ALT1	0x57	87	R / W
HYS1	0x58	88	R / W
ALD2	0x59	89	R / W
ALT2	0x5A	90	R / W
HYS2	0x5B	91	R / W
ALD3	0x5C	92	R / W
ALT3	0x5D	93	R / W
HYS3	0x5E	94	R / W
SETA	0x5F	95	R / W
CLO1	0x60	96	R / W
CHO1	0x61	97	R / W
CLO2	0x62	98	R / W
CHO2	0x63	99	R / W
TE	0x64	100	R / W
TS	0x65	101	R / W
TSPL	0x66	102	R / W
TSPH	0x67	103	R / W

Parameter	Register Address		R / W
	Hex	Dec	
CLO3	0x68	104	R / W
CHO3	0x69	105	R / W
RUCY	0x6A	106	R / W
WAIT	0x6B	107	R / W
PSL	0x6C	108	R / W
BITS	0x6D	109	R / W
IDNO	0x6E	110	R / W
BAUD	0x6F	111	R / W
INT	0x70	112	R / W
SVOS	0x71	113	R / W
PVOS	0x72	114	R / W
PVOH	0x73	115	R / W
PVFT	0x74	116	R / W
UNIT	0x75	117	R / W
ODU	0x76	118	R / W
HZ	0x77	119	R / W
INP2	0x78	120	R / W
ANL2	0x79	121	R / W
ANH2	0x7A	122	R / W
DP_2	0x7B	123	R / W
LSP2	0x7C	124	R / W
USP2	0x7D	125	R / W
SVL2	0x7E	126	R / W
SVH2	0x7F	127	R / W
PLL2	0x80	128	R / W
PHH2	0x81	129	R / W
SVO2	0x82	130	R / W
PVS2	0x83	131	R / W
PVH2	0x84	132	R / W
PVF2	0x85	133	R / W
UNI2	0x86	134	R / W
DIE	0x8C	140	R / W
DIS	0x8D	141	R / W
SET1	0x8E	142	R / W
SET2	0x8F	143	R / W
SET3	0x90	144	R / W
SET4	0x91	145	R / W
SET5	0x92	146	R / W
SET6	0x93	147	R / W
SET7	0x94	148	R / W
SET8	0x95	149	R / W
SET9	0x96	150	R / W
SET0	0x97	151	R / W
OUTY	0x9D	157	R / W
R-M	0x9E	158	R / W
CJS	0x9F	159	R / W
CJM	0xA0	160	R / W
CJT	0xA1	161	R
OBIT	0xA2	162	R
D_01	0xA5	165	R / W
D_02	0xA6	166	R / W
D_03	0xA7	167	R / W
D_04	0xA8	168	R / W
D_05	0xA9	169	R / W
D_06	0xAA	170	R / W
D_07	0xAB	171	R / W
D_08	0xAC	172	R / W
D_09	0xAD	173	R / W
D_10	0xAE	174	R / W
D_11	0xAF	175	R / W
D_12	0xB0	176	R / W
D_13	0xB1	177	R / W
D_14	0xB2	178	R / W
D_15	0xB3	179	R / W
D_16	0xB4	180	R / W



TAIWAN INSTRUMENT & CONTROL CO., LTD

Phone: +886-2-8226-1867  
Fax: +886-2-8226-1834

E-mail: [contact@fa-taie.com.tw](mailto:contact@fa-taie.com.tw)  
URL: <http://www.fa-taie.com.tw>